

Article number: 03467070

Description: Fluro Rod end EA 70D-2RS

Note: 70

Measures

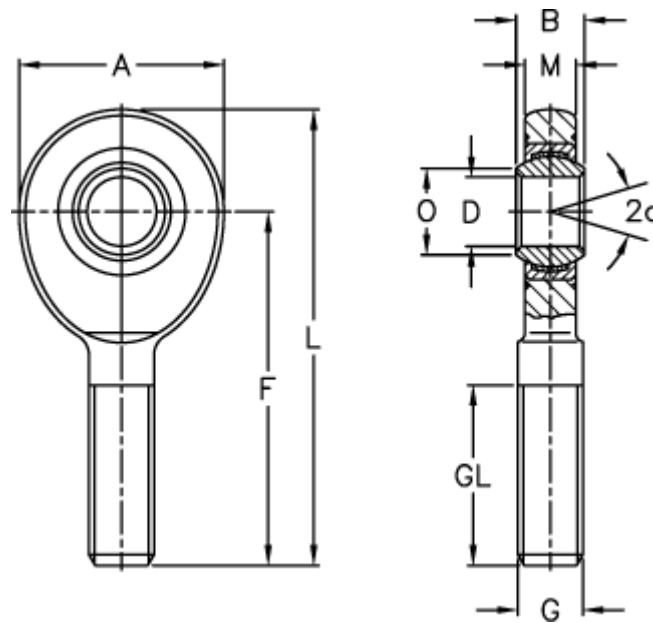

A	= 160	L	= 315
a (degrees)	= 6	M	= 42
B	= 49	O	= 77.9
D	= 70	Static drive kN	= 566
Dynamic drive (kN)	= 590	Weight	= 8200
F	= 235		
g	= M 56x4		
GL	= 125		